



OPERATORS MANUAL

SP360P



Do not operate equipment until you have read this Owner's Manual for Safety, Operation, and Maintenance Instructions.



CONTENTS

	Page
Index	2
General Components	3
Technical Specifications	4
Safety Guidelines	5
Operating Procedures	
Assembly	8
Getting Started	9
High Pressure Operation	10
Detergent Operation	11
Pump Maintenance	
Nozzle Cleaning	12
Water Inlet Screen Cleaning	12
Long-term Storage	13
Engine Instructions	
Engine Maintenance	14
Trouble Shooting	15
Limited Warranty Policy	16
Limited Extended Engine Warranty Policy	17



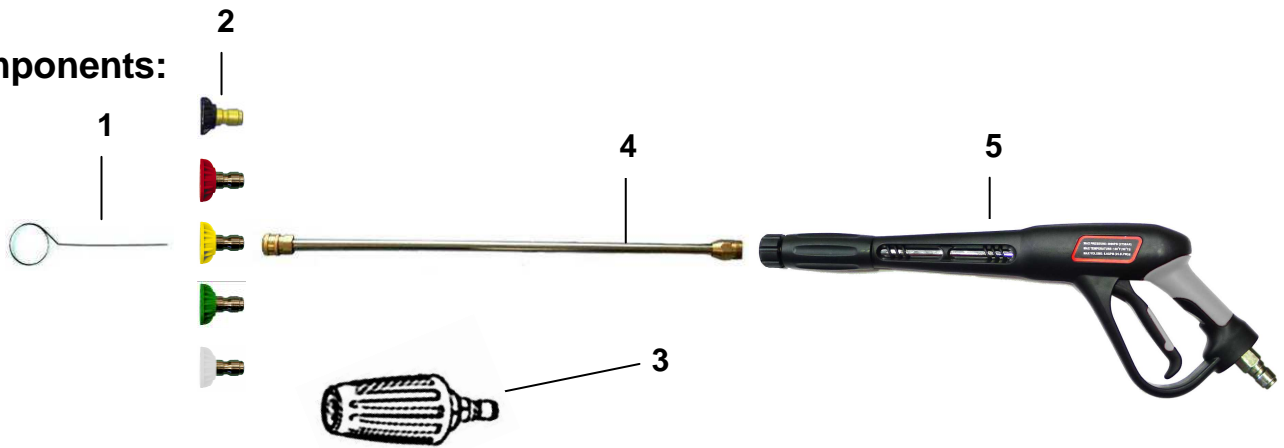

Components:

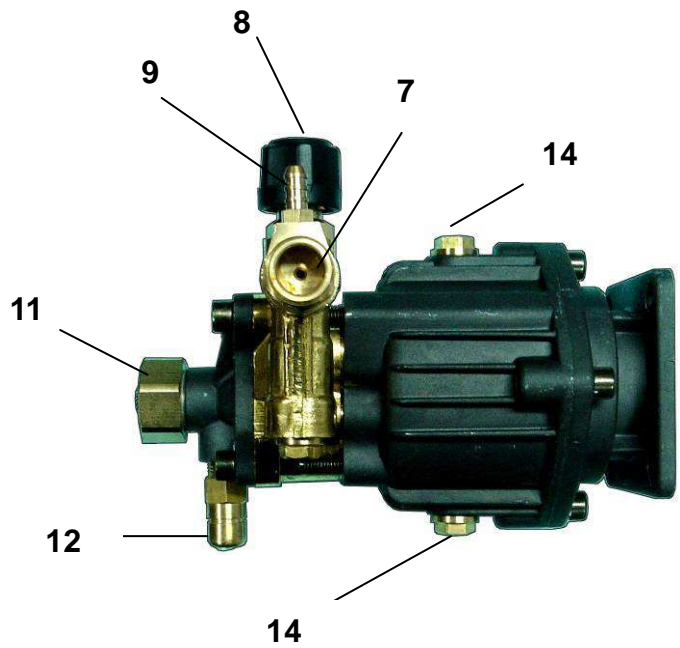
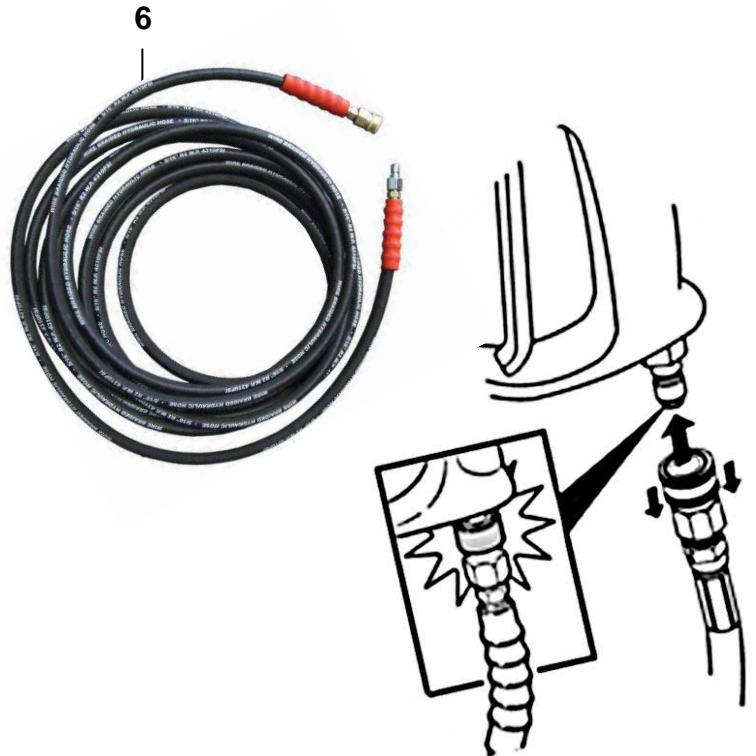

1. Nozzle cleaner
2. HP Nozzles
3. Turbo nozzle
4. Lance assembly
5. QD Trigger assembly
6. QD High pressure hose
7. High pressure outlet connector
8. Pressure adjustment knob
9. Chemical injector
10. Detergent pickup hose
11. Water inlet filter & connector
12. Thermal safety valve
13. Owner's manual
14. Oil drain plug



Technical Specifications:

		
ENGINE	Industrial Engine Model	
Type	Forced Air Cooling, OHV	4 Stroke
Spark Plug	NGK	BPR4ES
Lubrication	SAE 30 (SAE 10W30 for cold climates) Engine oil was drained at the factory for shipping	Engine Oil
Oil Quantity	Engine Oil Capacity	600ml
Power	Max Output power & revolutions kW/rpm	4.1kW @ 3600
Ignition	TCI (Transistor Controlled Ignition)	TCI
Fuel	Unleaded Petrol	Regular
PUMP Axial cam 8°	<ul style="list-style-type: none"> • Brass Pressure head • Anodized crankcase • Pressure adjustment • In-line water inlet filter • Thermal relief valve • Chemical injector (dosage rate 7:1) • triple stainless steel piston 	
Oil Type	SAE 30 Engine Oil The pump is supplied with oil from the factory	100ml
Pressure	Maximum pump pressure	3600 psi (248 bar)
Flow Rate	Maximum water volume	678 l/h 11.3 l/min
Recommended	Water supply pressure	@ 20psi

SAFETY GUIDELINES-----DEFINITIONS

This manual contains information that is important for you to know and understand. This information relates to protecting **YOUR SAFETY** and **PREVENTING EQUIPMENT PROBLEMS**. To help you recognize this information, we use the symbols below. Please read the manual and pay attention to these sections. **SAVE THESE DEFINITIONS/INSTRUCTIONS.**

<p style="text-align: center;">▲ DANGER</p> <p>DANGER indicates an imminently hazardous situation which, if not avoided, will result in death or serious injury.</p>	<p style="text-align: center;">▲ CAUTION</p> <p>CAUTION indicates a potentially hazardous situation which, if not avoided, may result in minor or moderate injury.</p>
--	--

<p style="text-align: center;">▲ WARNING</p> <p>WARNING indicates a potentially hazardous situation which, if not avoided, could result in death or serious injury.</p>	<p style="text-align: center;">▲ CAUTION</p> <p>CAUTION used without the safety alert symbol indicates a potentially hazardous situation which, if not avoided, may result in property damage.</p>
---	--

IMPORTANT SAFETY INSTRUCTIONS:





IMPROPER OPERATION OR MAINTENANCE OF THIS PRODUCT COULD RESULT IN SERIOUS INJURY, DEATH AND OR PROPERTY DAMAGE. READ AND UNDERSTAND ALL WARNINGS AND OPERATING INSTRUCTIONS BEFORE USING.

HAZARD	WHAT CAN HAPPEN	HOW TO PREVENT IT
<div style="border: 2px solid black; border-radius: 15px; padding: 10px; text-align: center;"> </div>	<ul style="list-style-type: none"> ● Spilled gasoline and its vapors can become ignited from cigarette sparks, electrical arcing, exhaust gases, and hot engine components such as the muffler. ● Heat will expand fuel in the tank which could result in spillage and possible fire explosion. ● Operating the pressure washer in an explosive environment could result in a fire. ● Materials placed against or near the pressure washer can interfere with its proper ventilation features causing overheating and possible ignition of the materials. ● Muffler exhaust heat can damage painted surfaces, melt any material sensitive to heat (such as siding, plastic, rubber, or vinyl), and damage live plants. ● Improperly stored fuel could lead to accidental ignition. Fuel improperly secured could get into the hands of children or other unqualified persons. 	<ul style="list-style-type: none"> ● Shut off engine and allow it to cool before adding fuel to the tank. ● Use care in filling tank to avoid spilling fuel. Move pressure washer away from fueling area before starting engine. ● Keep maximum fuel level 1/2" below top of tank to allow for expansion. ● Operate and fuel equipment in well ventilated areas free from obstructions. Equip areas with fire extinguishers suitable for gasoline fires. ● Never operate pressure washer in an area containing dry brush or weeds. ● Always keep pressure washer a safe distance away from surfaces (such as houses, automobiles, or live plants) that could be damaged from muffler exhaust heat. ● Store fuel in container approved for gasoline, in a secure location away from work area.

<div style="border: 2px solid black; border-radius: 15px; padding: 10px; text-align: center;"> </div>	<ul style="list-style-type: none"> ● Breathing exhaust fumes will cause serious injury or death. ● Some cleaning fluids contain substances which could cause injury to skin, eyes, or lungs. 	<ul style="list-style-type: none"> ● Operate pressure washer in a well ventilated area. Avoid enclosed areas such as garages, basements, etc. ● Never operate unit in a location occupied by humans or animals. ● Use only cleaning fluids specifically recommended for high pressure washers. Follow manufacturer's recommendations.
---	--	--

HAZARD	WHAT CAN HAPPEN	HOW TO PREVENT IT
	<ul style="list-style-type: none"> • Unsafe operation of your pressure washer could lead to serious injury or death to you or others. • The spray gun/wand is a powerful cleaning tool that could look like a toy to a child. • Reactive force of spray will cause gun/wand to move and could cause the operator to slip or fall, or misdirect the spray. Improper control of gun/wand can result in injuries to self and others. 	<ul style="list-style-type: none"> • Become familiar with the operation and controls of the pressure washer. • Keep children away from the pressure washer at all times. • Never attempt to defeat the safety features of this product. • Do not operate machine with missing, broken, or unauthorized parts. • Never leave wand unattended while unit is running. • Keep work area free of obstacles. • Stand on a stable surface and grip gun/wand firmly. Expect the gun to kick when triggered.

	<ul style="list-style-type: none"> • Spray directed at electrical outlets or switches, or objects connected to an electrical circuit, could result in a fatal electrical shock. 	<ul style="list-style-type: none"> • Unplug any electrically operated product before attempting to clean it. Direct spray away from electric outlets and switches.
---	--	---

	<ul style="list-style-type: none"> • Your washer operates at fluid pressures and velocities high enough to penetrate human and animal flesh, which could result in amputation or other serious injury. Leaks caused by loose fittings or worn or damaged hoses can result in injection injuries. DO NOT TREAT FLUID INJECTION AS A SIMPLE CUT! See a physician immediately! 	<ul style="list-style-type: none"> • Never place hands in front of nozzle. • Direct spray away from self and others. • Never hold onto the hose or fittings • Do not allow hose to contact muffler. • Never attach or remove wand or hose fittings while system is pressurized. • Use only hose and high pressure accessories rated for pressure higher than your pressure washer's p.s.i. • To relieve system pressure, shut off engine, turn off water supply, and pull gun trigger until water stops flowing. • Always wear eye protection • Never attempt to drink from the high pressure lance.
---	---	---

	<ul style="list-style-type: none"> • Use of acids, toxic or corrosive chemicals, poisons, insecticides, or any kind of flammable solvent with this product could result in serious injury or death. 	<ul style="list-style-type: none"> • Do not use acids, gasoline, kerosene, or any other flammable materials in this product. Use only household detergents, cleaners and degreasers recommended for use in pressure washers. • Wear protective clothing to protect eyes and skin from contact with sprayed chemicals.
---	--	---

HAZARD	WHAT CAN HAPPEN	HOW TO PREVENT IT
	<ul style="list-style-type: none"> • Contact with hot surfaces, such as engine's exhaust components, could result in serious burns. 	<ul style="list-style-type: none"> • During operation, touch only the control surfaces of the pressure washer. Keep children away from the pressure washer at all times. They may not be able to recognize the hazards of this product.

	<ul style="list-style-type: none"> • Fuel or oil can leak or spill and could result in fire or breathing hazard, serious injury or death. Fuel or oil leaks will damage carpet, paint or other surfaces in vehicles or trailers. 	<ul style="list-style-type: none"> • If pressure washer is equipped with a fuel shut-off valve, turn the valve to the off position before transporting to avoid fuel leaks. If pressure washer is not equipped with a fuel shut-off valve, drain the fuel from tank before transporting. Only transport fuel in an OSHA approved container. Always place pressure washer on a protective mat when transporting to protect against damage to vehicle from leaks. Remove pressure washer from vehicle immediately upon arrival at your destination.
---	---	--



- The powerful spray from your pressure washer is capable of causing damage to surfaces such as: wood, glass, automobile paint, auto striping and trim, and delicate objects such as flowers and shrubs. Before spraying, check the item to be cleaned to assure yourself that it is strong enough to resist damage from the force of the spray. Avoid the use of the concentrated spray stream except for very strong surfaces like concrete and steel.
- Operating unit with the water supply shut-off will result in equipment damage. Operating the pressure washer with water supply shut-off will void your warranty.
- You should never run your pressure washer for more than 2 minutes without pulling the trigger. Pulling the trigger allows cool water to enter the pump and maintains a normal operating temperature.

Read Owner's Manual. Do not operate equipment until you have read Operation Manual for **Safety**, **Operation**, and **Maintenance Instructions**. Damage caused by incorrect operation **will not** be covered under warranty.

Assembly:

Unpacking Pressure Washer

- Set carton on a rigid, flat surface. Remove all loose parts and packing. Leave pressure washer in carton.

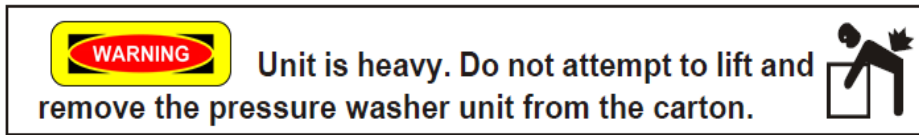

- Using a box cutter carefully open the carton completely by cutting the four corners, allowing the sides to lay flat. Leave pressure washer on carton while installing wheels and rubber feet.

Assembling the Wheels

- Fit the axles into the axle ports as shown,
- Secure the wheels to the axles with nyloc nut and washer.

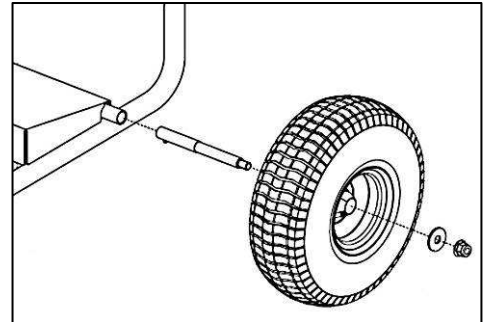

NOTE: Do not over tighten the nuts; the wheels must be able to rotate freely.

Assembling the Rubber Feet

- Fit the rubber feet to the legs as shown with nuts and washers provided.

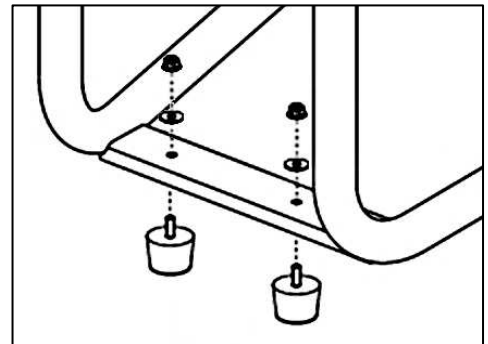

Assembling the Gun/ Hose Hook

- Fit the hooks into the position shown and secure using the washers and nuts on the bracket.

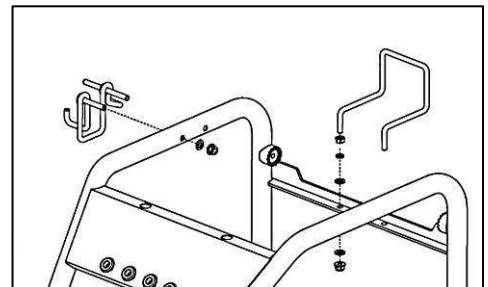

Getting started



PRE START CHECKLIST

Once you reach this point ensure you have done the following:

- All safety instructions read and understood
- All hose connections are tightened and hoses free of kinks
- Adequate amounts of lubrication and fuel have been added to the engine
- Water source connected and turned on; Note: *cold water only*
- All operation instructions read and understood

* **The pump has been oiled at the factory – the engine has not.**

Preparation before starting:

- **Add SAE 30 oil** (SAE 10W30 multigrade for cold climates) **to the engine (600ml)**

Note: There will be a residual amount of oil in the engine from factory testing

- Check the engine has an adequate fuel supply (unleaded, regular gasoline)
- Make sure that the work area has sufficient ventilation
- Ensure the ignition cable is secured to the spark plug
- **Ensure water supply is turned on**

1. Turn the fuel cock to the on position
2. Move the engine switch to the “on” position
3. Move the choke lever to the on position

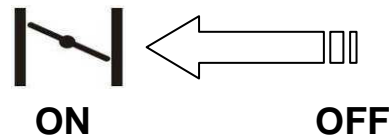
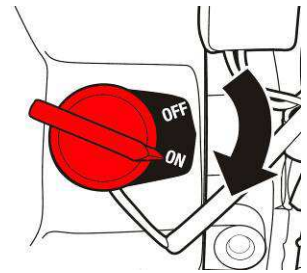

TO START:

4. Pull the trigger gun lever, to prevent pressure build up within the pump while starting. For safety reasons ensure the nozzle is removed whenever starting the unit. **Note** * Failure to open the trigger valve while starting, may overload the recoil starter causing damage to the mechanism.



5. Engage the recoil starter by pulling the rope handle out 25 to 50mm (1 to 2”).
6. Then deliver a short sharp pull to crank the engine over. In general most units will fire and start on choke after two or three pulls.

7. Reduce choke as the engine warms up. The choke should be completely off after 2 or 3 minutes.

TO STOP:

1. Move the engine stop switch to the “stop” position. The engine will stop immediately.
2. Turn water supply off.

HIGH PRESSURE OPERATION

Never pull the hose to move the unit. This could damage hose and/or pump inlet.

Never allow pump to run with water hose turned off or kinked. Shutting off the water supply to the pump while it is operating may cause serious pump damage.

Do not let hoses contact HOT engine muffler during or immediately after use, as this will damage the hose.

Interchangeable Nozzles:



- Pull back the quick connect lock ring, firmly insert the desired nozzle and then release the lock ring.
- Make sure the spray nozzle is properly locked in place with its quick coupler, if the collar is not (Forward) in the locking position, the nozzle may become a dangerous projectile. The O-ring from your quick coupler socket may also be blown out of place.

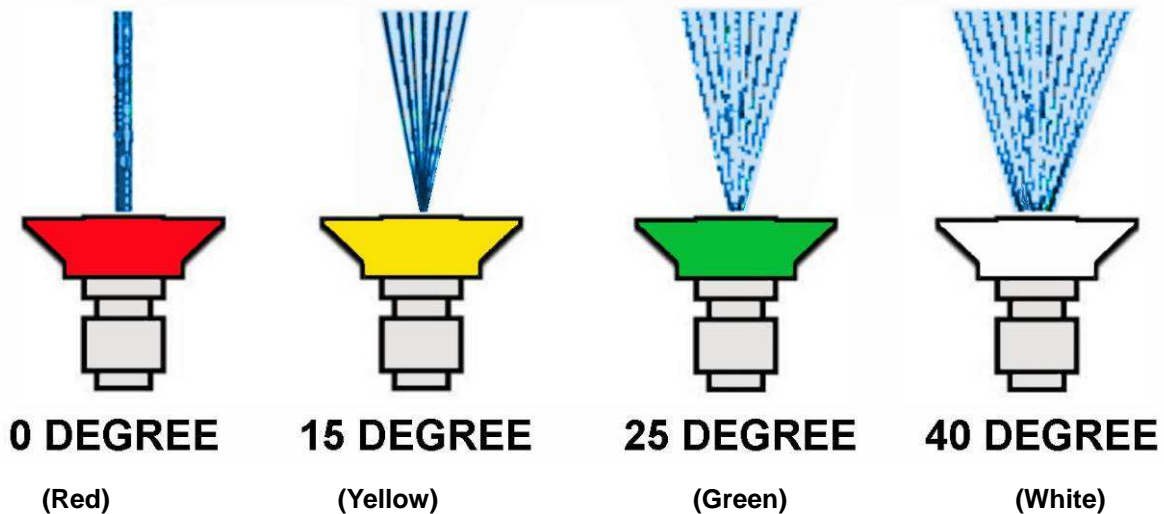

Explanation:

0° nozzle setting – A pinpoint stream. This nozzle stream is very powerful and covers a very small area of cleaning. Only to be used on surfaces that can withstand this high pressure (metal or concrete).

15° to 25° nozzle setting – Used for less powerful stream which can cover a wider area. This nozzle setting is also very powerful and should only be used on surfaces that can withstand this high pressure.

40° nozzle setting – Used for the least powerful stream and covers a wide area of cleaning. This nozzle setting should be used for most general cleaning jobs.

Pressure Adjustment:

The maximum working pressure is pre-set at the factory and can not be overridden. By turning the pressure adjustment knob anti-clockwise you can reduce both the pressure and water volume being supplied from the pump.

Low Pressure Detergent Operation:

The Black Tip – will lower the pressure and allow chemical to be drawn through the downstream chemical injector.

- Change the high pressure nozzle for the Detergent (Black) Nozzle. (Be sure the quick coupler is fully engaged before pulling the trigger)
- The chemical injector will only work when this (black) nozzle is used.
- Push the ¼" clear plastic hose to the inlet barb of the chemical injector located near the high pressure hose connection (item 8, page 2).
- Insert the loose end of the detergent pick up hose into the desired chemical.



Be sure to flush the injection system with clean water after use.

- Place the chemical injector hose in a bucket of clean water and operate for one minute.

Thermal Relief Valve:

During normal operation, the cold water from your water supply passes through the inside of the pressure pump allowing the pump to maintain a normal operating temperature. When you let go of the trigger, the pump enters by-pass mode and re-circulates water within the pump.

If the unit is left in the by-pass mode for more than two (2) minutes, the water temperature may rise to a dangerous level causing cavitation and possible damage to internal components of the pump. As a safe guard against damage from overheating, pumps are equipped with a thermal relief valve. This safety valve will open when the internal water temperature becomes too high, once cool the valve will close again automatically.

Do not attempt to run hot water into the pump or allow your unit to operate in the by-pass mode for long periods of time (2 minutes max), as overheating of the pump will cause component damage.

Shut Off Procedure:

1. Turn engine switch to off position. **NOTE: NEVER turn the water off with the engine running.**
2. Move fuel tap to off position.

MAINTENANCE:

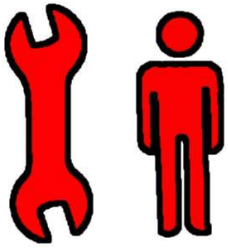

WHEN DOING MAINTENANCE, YOU MAY BE EXPOSED TO HOT SURFACES, WATER PRESSURE, MOVING PARTS, OR FIRE WHICH MAY RESULT IN SERIOUS INJURY OR EVEN DEATH. BEFORE PERFORMING ANY MAINTENANCE OR REPAIR, LET THE ENGINE COOL DOWN COMPLETELY AND RELEASE ALL WATER PRESSURE. THE ENGINE CONTAINS FLAMMABLE FUEL. DO NOT SMOKE OR WORK NEAR OPEN FLAMES WHILE PERFORMING MAINTENANCE.

Nozzle cleaning:

If the nozzle becomes clogged with foreign material, such as sand, flow will cease or become restricted. Clean the nozzle immediately using the nozzle cleaner supplied and the following instructions:

- Shut off the pressure washer and turn off the water supply.
- Pull trigger on gun handle to relieve any built up water pressure.
- Remove the nozzle from the lance assembly.
- Turn the nozzle end up.
- The nozzle hole is approximately 1mm in diameter, it is the smallest hole in the system, even a single grain of sand can block the nozzle.
- Clean the nozzle using the nozzle cleaner provided or wire of appropriate size. Insert into the nozzle end and push. Remember that any obstruction will have been lodged in place under very high pressure and may require an equal amount of force in the opposite direction to dislodge it.
- It is important that you see the obstruction come out of the lance, otherwise the nozzle may block again.
- Reconnect nozzle to lance and turn on water supply.
- Recommence operation.



Water Inlet Screen Cleaning:

The water inlet filter screen should be checked periodically and cleaned whenever necessary.

1. Remove the water inlet hose connection to expose the inlet filter.
2. Remove the filter screen and flush with clean water from both sides.
3. Replace the cleaned filter screen into the water inlet connector.
4. Tighten securely (clockwise)



Do not operate the pressure washer without a water inlet filter installed.

Pump Oil :

- The pump has been oiled at the factory.
- The pump lubrication should be changed every 12 months or 200 operating hours.

LONG-TERM STORAGE:

Before you store the pressure washer, make sure you do the following:

1. Remove fuel from engine or add fuel stabilizer, such as "Sta-Bil" to the gasoline to prevent gumming, and operate unit normally for five minutes.
2. If adding stabilizer, connect water supply and high pressure hose to pump.
3. Ensure water supply is turned on, start pressure washer and depress gun trigger to avoid running the unit in the "by-pass mode."
5. Disconnect spark plug wire and remove spark plug. Pour one teaspoon of engine oil into the spark plug hole. Place a rag over spark plug hole and pull rope slowly several times to lubricate cylinder, replace spark plug and lead.
6. Protect the high pressure hose, gun and wand from damage (such as being stepped on or run over).

TO PREVENT INTERNAL CORROSION OR FREEZING:

Items needed: 100cm piece of garden hose or equivalent and antifreeze (approximately 100 ml.)

1. To winterize the pressure pump, prevent the engine from starting by disconnecting the spark plug wire from the engine and remove high pressure hose from the pump. Add automotive antifreeze corrosion inhibitor through the water inlet, place the garden hose direct into the anti freeze container. Pull engine rope several times until antifreeze comes out of high pressure outlet connector. You have now displaced the water in the pump with corrosion inhibitor.
2. Remove all water from high pressure hose, gun, and wand. To do so, disassemble high pressure hose from gun. Drain all water from hose. Hold gun/wand assembly in a vertical position with the nozzle pointing down, and pull gun trigger to remove any water.

ENGINE MAINTENANCE:

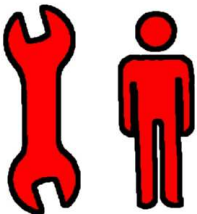

WHEN DOING MAINTENANCE, YOU MAY BE EXPOSED TO HOT SURFACES, WATER PRESSURE, MOVING PARTS, OR FIRE WHICH MAY RESULT IN DEATH. BEFORE PERFORMING ANY MAINTENANCE OR REPAIR, LET THE ENGINE COOL DOWN COMPLETELY AND RELEASE ALL WATER PRESSURE. THE ENGINE CONTAINS FLAMMABLE FUEL. DO NOT SMOKE OR WORK NEAR OPEN FLAMES WHILE PERFORMING MAINTENANCE.

1. If the engine can not be started or starting is difficult, first check whether the fuel system has fresh fuel and adequate oil level.
2. Secondly check the spark plug. Remove the spark plug cap, take out the spark plug, clean any carbon deposits and adjust the plug gap to specified gap and reassemble.
3. As well you should ensure that the inlet of the air filter and exhaust outlet are clean. Maintain a clean air filter. Inspect regularly and clean or replace as necessary.

Note* Dusty conditions will require high filter maintenance.

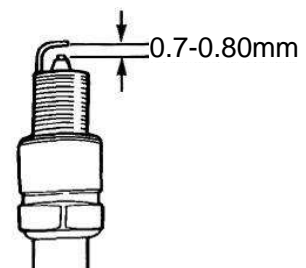

ENGINE TROUBLE SHOOTING GUIDE

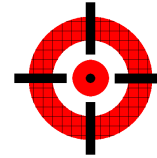

When the engine will not start:

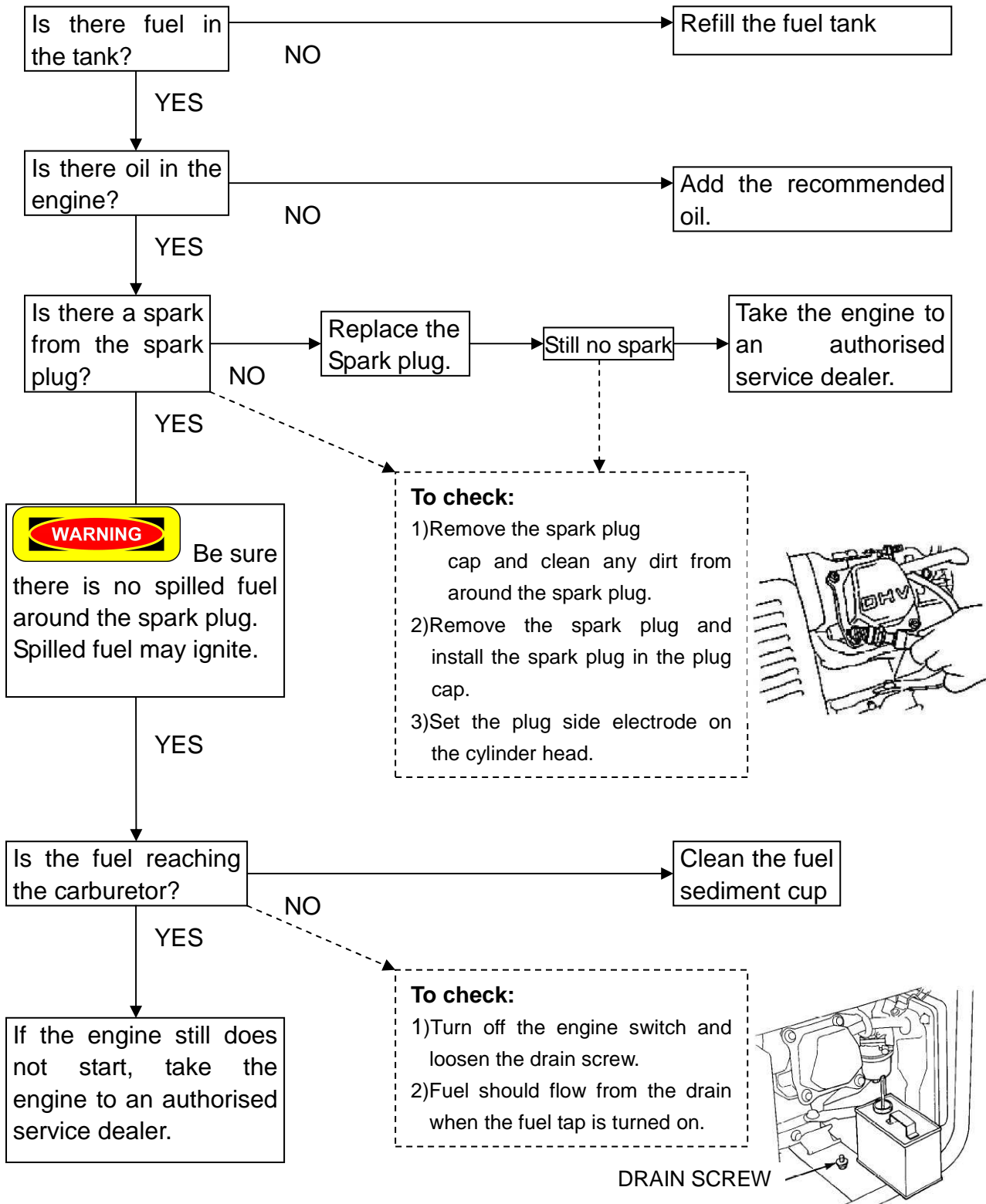

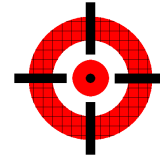

PUMP TROUBLE SHOOTING GUIDE

PROBLEM	CAUSE	CORRECTION
Pump will not draw Chemicals	<ol style="list-style-type: none"> 1. Low pressure Nozzle (Black) not fitted. 2. Chemical filter clogged. 3. Chemical filter not in chemical. 4. Chemical solution too thick. 5. Pressure hose too long. 6. Chemical build-up in chemical injector. 	<ol style="list-style-type: none"> 1. See Nozzle Selection. 2. Clean filter. 3. Ensure end of chemical hose is fully submerged into chemicals. 4. Dilute chemical. Chemical solutions should have same consistency as water. 5. Lengthen water supply instead of pressure hose. 6. Have parts cleaned or replaced by authorised dealer.
No or low pressure (after period of normal use).	<ol style="list-style-type: none"> 1. Worn seal or packing. 2. Worn or obstructed valves. 3. Worn unloader piston. 4. Worn E-Z start valve. 	Have parts cleaned or replaced by authorised dealer.
Water leaking at spray gun/lance connection.	<ol style="list-style-type: none"> 1. Worn or broken O-ring. 2. Loose hose connection. 	<ol style="list-style-type: none"> 1. Check and replace O-ring. 2. Tighten hose connection.
Water leaking at pump.	<ol style="list-style-type: none"> 1. Loose connections. 2. Pistons packing worn. 3. Worn or broken O-rings. 4. Pump head or tubes damaged from freezing. 	<ol style="list-style-type: none"> 1. Check and replace O-rings. 2. Tighten hose connection. 3. Tighten all connections. 4. Have parts cleaned or replaced by authorised dealer.
Oil leaking at pump.	<ol style="list-style-type: none"> 1. Oil seals worn. 2. Loose drain plug. 3. Worn drain plug O-ring. 4. Worn fill plug O-ring. 5. Pump overfilled. 6. Incorrect oil used. 7. Vent plug clogged. 	<ol style="list-style-type: none"> 1. Have parts cleaned or replaced by authorised dealer. 2. Tighten drain plug. 3. Inspect and replace O-rings. 4. Check for correct amount of oil. 5. Drain and refill with correct type and amount of oil. 6. Clean vent plug, use air hose to free if blocked, if problem persists replace vent plug.
Pump pulsates.	Nozzle obstructed.	See "Nozzle Cleaning" section



Austech Industries Pty Ltd A.B.N. 19 010 548 464
23 Iris Place, Acacia Ridge, 4110
PO Box 715
Archerfield Qld 4108
Brisbane Australia
T: (07) 3723 1500 F: (07) 3723 1555

Limited Warranty Policy

This Limited Warranty applies only to new products* distributed by Austech Industries Pty Ltd ("Austech Industries"). It is a condition of this Limited Warranty Policy that the purchaser read the owner's manual for the product and only use the product to the extent or for the purposes stated therein. The purchaser must also ensure that all servicing requirements are completed as listed in the owner's manual (said servicing is at the owner's expense). We recommend that all servicing is completed by an authorised service agent and that records of said servicing are retained by the purchaser as proof in the event of a warranty claim.

Whilst the owner's manual, packaging, and/or other documentation supplied with Austech Industries' products may provide details in respect of a Limited Warranty, the terms set out herein supersede these matters, and this Limited Warranty applies in their place. This warranty is no less advantageous than otherwise described in such other documentation.

Austech Industries agrees, subject to the terms and conditions specified below, to repair or replace at Austech Industries' cost, the product purchased by you when the product does not perform in accordance with its specifications during the limited warranty period, due to any fault in manufacturing, materials and/or workmanship. Austech Industries is not liable to repair or replace products that the purchaser uses in a manner that is inconsistent with the owner's manual or in the circumstances set out in paragraphs 1.1 – 1.7 below.

The benefits to the purchaser under this warranty are in addition to other rights and remedies under the *Competition and Consumer Act 2010* (Cth).

The limited warranty period, within which a defect in the product must appear, commences from the date of purchase and ceases on expiration of the specified term below.

The Limited Warranty Period

- SP Jetwash Pump Warranty - 24 months
- Torini Engines - 36 months
- Accessories – 12 months

The purchaser's attention is drawn to the following

1. To the extent permitted by law and subject to this Limited Warranty, and as part of the terms of the sale of the equipment or part thereof: Austech Industries shall not be liable for any form of loss, damage, cost, injury or harm of any kind (whether direct, indirect, special or consequential) howsoever arising from the use or supply of the equipment to the purchaser.

Exclusions to Limited Warranty Policy

This Limited Warranty will not apply where the equipment or any part thereof:

- 1.1 Fails due to an accident (including liquid spillage), abuse, misuse, neglect or normal wear and tear;
- 1.2 Has been used in a manner other than for which it was originally designed;
- 1.3 Has been tampered with or is otherwise than as supplied by Austech Industries;
- 1.4 Where any damage, malfunction or other failure of the equipment or any part thereof resulted directly or indirectly from unauthorized persons, adjusting or failing to adjust any part requiring normal maintenance and service (examples include adjustment of tappets, air filter maintenance, lubrication and tightening of screws nuts and bolts);
- 1.5 Malfunctions due to the use of defective or incompatible accessories;
- 1.6 Is damaged by lightning or thunderstorm activity; or
- 1.7 Has been transported to a country where no authorised Service Agents exist.

Claiming warranty

This Limited Warranty may be claimed on in the following manner:

- 2.1 In order to make a claim under this Limited Warranty, the purchaser must deliver the equipment or any part thereof to an Austech Industries authorised repair agent and pay all costs of transportation and all costs incidental to making a claim under this Limited Warranty. The purchaser must first contact Austech Industries (contact details described above) and request the delivery address of an Austech Industries authorised repair agent. The purchaser must deliver to the repair agent written reasons why the purchaser considers that the purchaser has a claim under this Limited Warranty and must provide all necessary details, including:
 - The place, date and from whom the unit or part was purchased.
 - The unit or part involved, Model and Serial Number.
 - The defect, malfunction or failure in respect of which the claim is being made.
 - Proof of service of the unit or part (if applicable)
 - Proof of purchase in respect of the unit or part.
- 2.2
- 2.3 If the Limited Warranty claim is valid, the repair agent will carry out repairs and return the product at no charge to the purchaser. These repairs are limited to the Limited Warranty fault identified and as such will not include any other faults due to misuse, abuse, failure to maintain, fair wear and tear or the replacement of serviceable items such as oil, spark plugs, air filters, fuel etc.

Our goods come with guarantees that cannot be excluded under the Australian Consumer Law. You are entitled to a replacement or refund for a major failure and for compensation for any other reasonably foreseeable loss or damage. You are also entitled to have the goods repaired or replaced if the goods fail to be of acceptable quality and the failure does not amount to a major failure.

* SP Jetwash and Torini are brand names of products distributed by Austech Industries

Note # Units which are failing to perform in accordance with specifications due to **non-warrantable** causes will be subject to freight, repair and or quote charges.

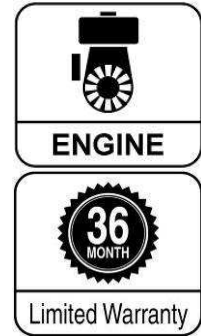

Limited Extended Engine Warranty Policy

36 Month or 3 year Limited Extended Engine Warranty:

2. **The 36 Month**, Limited Extended Engine Warranty applies only to the original purchaser of Torini Engines distributed by Austech Industries. The Limited Extended Engine Warranty period commences from the date of purchase and runs in conjunction with the standard 12 months Limited Warranty for the pressure washer. It is a condition of this Limited Extended Engine Warranty Policy that all servicing requirements are completed as listed in the Owners Manual.
3. To the extent permitted by law and subject to the Limited Warranty, and as part of the terms of the sale of the engine or part thereof: Austech Industries shall not be liable for any form of loss, damage, cost, injury or harm of any kind (whether direct, indirect, special or consequential) howsoever arising from the use or supply of the equipment to the purchaser.
 - **Scope of coverage:** - 36 Months (3 years) from date of purchase
- a) **The Limited Extended Engine Warranty covers the following specific parts only:** the cylinder head, cylinder block crankshaft, connecting rods, piston, flywheel, camshaft and timing gears. The Warranty Period for both the standard 12 month limited warranty and the limited extended engine warranty begins on the date of purchase to the original retail purchaser and is valid only until the applicable warranted period has passed.

Company responsibilities:

4. Austech Industries agrees, subject to the terms and conditions specified, to effect warranty repairs within a reasonable amount of time (30 days) at no charge to the owner, the engine purchased by you when the above specified engine components fail to perform in accordance to specifications due to any fault in manufacturing, materials and/or workmanship, during the 36 Month Limited Extended Engine Warranty period.

The owner's responsibilities:

- ❖ As the engine owner, you are required to carry out the maintenance and servicing requirements as listed in your Owners Manual (said servicing is at the owner's expense). We recommend that all servicing is completed by an authorised service agent and that records of said servicing and scheduled maintenance are retained by the purchaser as proof in the event of a warranty claim. In the event of a claim, you (the owner) are responsible for presenting your engine to a service dealer for inspection as soon as a problem becomes evident.

Exclusions to Limited Extended Engine Warranty Policy:

This Warranty does not cover the cost of shipping the product to or from the Warranty repair facility.

This Warranty does not cover the cost of parts and / or labor necessary to carry out normal servicing or maintenance.

The Limited Extended Engine Warranty Policy will not apply where the engine or any part thereof:

- 1.1 Fails due to an accident (including liquid spillage), abuse, misuse, neglect or normal wear and tear.
- 1.2 Has been used in a manner other than for which it was originally designed.
- 1.3 Has been tampered with or is otherwise than as supplied by Austech Industries.
- 1.4 Where any damage, malfunction or other failure of the equipment or any part thereof resulted directly or indirectly from unauthorized persons, adjusting or failing to adjust any part requiring normal maintenance and service. Examples include adjustment of tappets, air filter maintenance, lubrication and tightening of screws nuts and bolts.
- 1.5 Malfunctions due to the use of defective or incompatible parts or accessories.
- 1.6 Is damaged by acts of God, Lightning or thunderstorm activity.
- 1.7 Has been transported to a country where no authorised Service Agents exist.

Our goods come with guarantees that cannot be excluded under the Australian Consumer Law. You are entitled to a replacement or refund for a major failure and for compensation for any other reasonably foreseeable loss or damage. You are also entitled to have the goods repaired or replaced if the goods fail to be of acceptable quality and the failure does not amount to a major failure.

This Warranty does not cover consumable parts such as, but not limited to, fuel, filters, belts, hoses, lubricants and cleaning fluids.